

Model: Steelworx Center Post Dugout Shelter, 12' x 16'
Model # CPD-1216-SW

Manufacturing Mission: To provide all prefabricated components and installation instructions for a 12' wide by 16' long (measured from eave to eave) free standing bolt together, tubular steel constructed shelter kit.

Design Criteria: Structure is typically designed for a 25 lb live load and a 90 mph wind load capacity, but can be designed based on specific site requirements upon request. All structural members are ASTM A-500 U.S. grade B steel. Welded connection plates shall be ASTM A-36 hot rolled steel. All fabrication performed to latest AISC standards by AWS Certified welders. All framing connections are done using A325 grade bolts within concealed access openings from above and will later be concealed by the roofing. All roof framing shall be flush against the roof decking to eliminate the possibility of bird nesting.

Tubular Steel Columns and Beams: Standard column dimension shall be 7" x 5" x 3/16" tubular steel welded to 5/8" base plates for surface mounting. Main support beams are 7" x 5" x 3/16" and purlins are 5" x 3" x 1/8". Steel sizes are preliminary and may change due to ongoing review and final engineering.

Roofing: 24 Ga. pre-cut steel Multi-Rib panels with Kynar 500 finish in a variety of colors with white underside. Standard roof slope is a 2/12 pitch with a eave height of 8'-0". Attached to structural framing with exposed self tapping screws painted to match roof color. Matching 24 Ga. trim included.

Frame Finish: All steel framework will receive a corrosion protective TGIC Polyester powder coat, electro-statically applied and cured at 400°F. A large selection of standard colors are available.

Foundation: All columns need to be anchored to concrete footings (footing design provided separately). Columns can be surface mounted to footings with anchor bolts at or below finish slab elevation or they can be embedded directly into the footing without base plates upon request. Anchor bolts and bracing templates are included. Optional base plate covers are available at an additional cost.

Hardware: All structural hardware and roofing fasteners shall be provided.

Warranty: 10 years against manufacturer defects.

Not Included: Concrete work of any kind, unloading of product and installation.

Additional Options: Visit www.Coverworx.net or see the current catalog for the latest available options and upgrades.

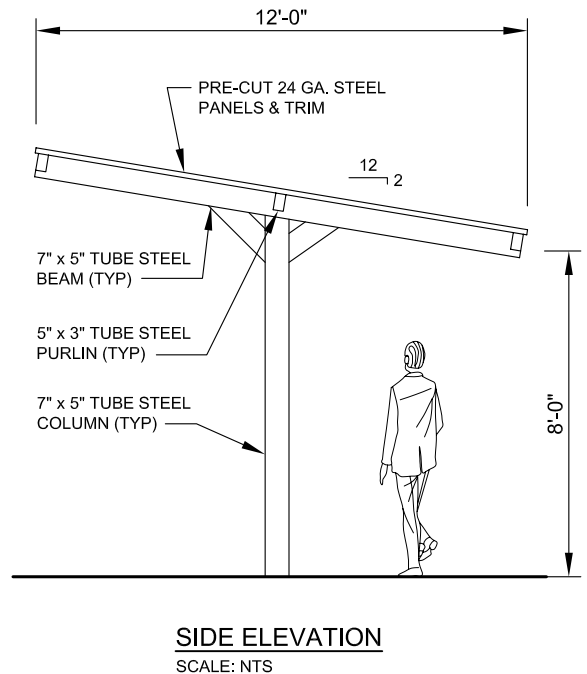
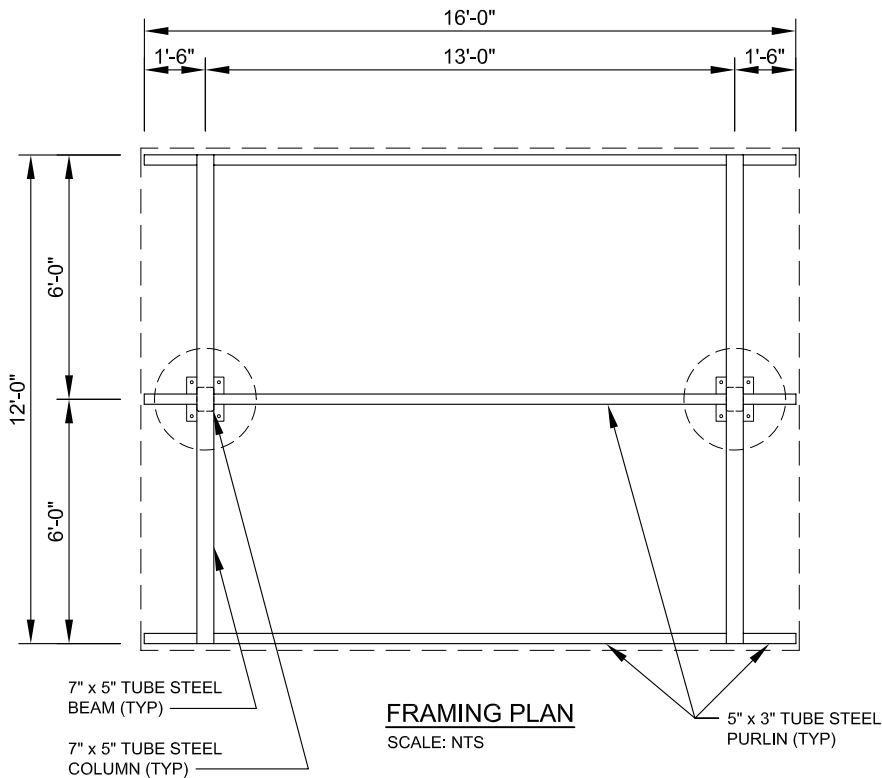

11800 East 9 Mile Road
 Warren, MI 48089
 Office: (586) 486-1088
 Fax: (586) 754-9130
 Toll Free: (800) 657-6118
 Email: info@coverworx.net
www.CoverWorx.net

Steelworx Center Post Dugout Shelter - 12' x 16'

Model: CPD-1216-SW

DESIGN SPECIFICATIONS