

Model: Woodworx Glulam Arch Beam Shelter, 24' x 36', Model # GAB-2436-WW

Lumber: Laminating lumber shall be kiln-dried, with 15% moisture content, Southern Yellow Pine graded to meet the requirements of Standard Specifications for Structural Glued Laminated Timber, AITC 117. Lumber combination shall be determined by the design requirements for each component and designated on the fabricator's shop drawings.

Treated Components: All treated components must be treated prior to gluing with pentachlorophenol Type "C". All treated components with ground contact, must be treated prior to gluing, at .6 lbs. per cubic foot with pentachlorophenol Type "C". All treated components not in ground contact, must be treated prior to gluing, at .3 lbs. per cubic foot with pentachlorophenol Type "C". Waterborne treatment will not be accepted.

Adhesives: Adhesives shall be wet-use (waterproof) complying with ANSI/AITC A190.1-latest edition.

Columns: Powder coated steel tube columns, surface mounted on concrete footings (concrete footing design and material not included). Also available with laminated wood columns embedded into concrete footings.

Curved-Tapered Beams: Glulam beams to be fabricated with #1 Grade, kiln-dried, with 15% moisture content, Southern Yellow Pine.

Roof Deck: Two-inch (nominal) #1 Grade, end matched, single tongue and groove with V-joint bottom face, kiln-dried, to an average of 15% moisture content, Southern Yellow Pine. Galvanized 16d nails shall be provided.

Fascia: 2" x 6" fascia, Southern Yellow Pine, #1 SPIB Grade, pressure-treated at .3 lbs. per cubic foot with pentachlorophenol Type "C" in accordance with AWWA Standards.

Roofing: 29 Ga. Kynar finished, multi-rib precut metal roof panels. Also available with asphalt shingles or standing seam metal roofing.

Hardware: All steel and hardware for beam and column connections shall be provided. Steel connections to be powder coated.

Design: The structural systems are designed to sustain actual dead load in conjunction with 30 PSF live load or 20 PSF wind load, whichever combination is critical.

Appearance Grades: AITC Architectural grade. Exposed faces of glulam members to receive one coat of factory-applied clear penetrating sealer.

Protection: Laminated Members shall be individually wrapped.

Storage and Erection: The general contractor is responsible for protection of the materials after arrival at destination. If stored temporarily, members should be placed on blocks well off the ground and separated with wood strips so that air can circulate around each member. Cover top and bottom with moisture resistant paper. Use non-marring slings when handling.

Shop Drawing: The fabricator shall furnish a complete set of installation drawings.

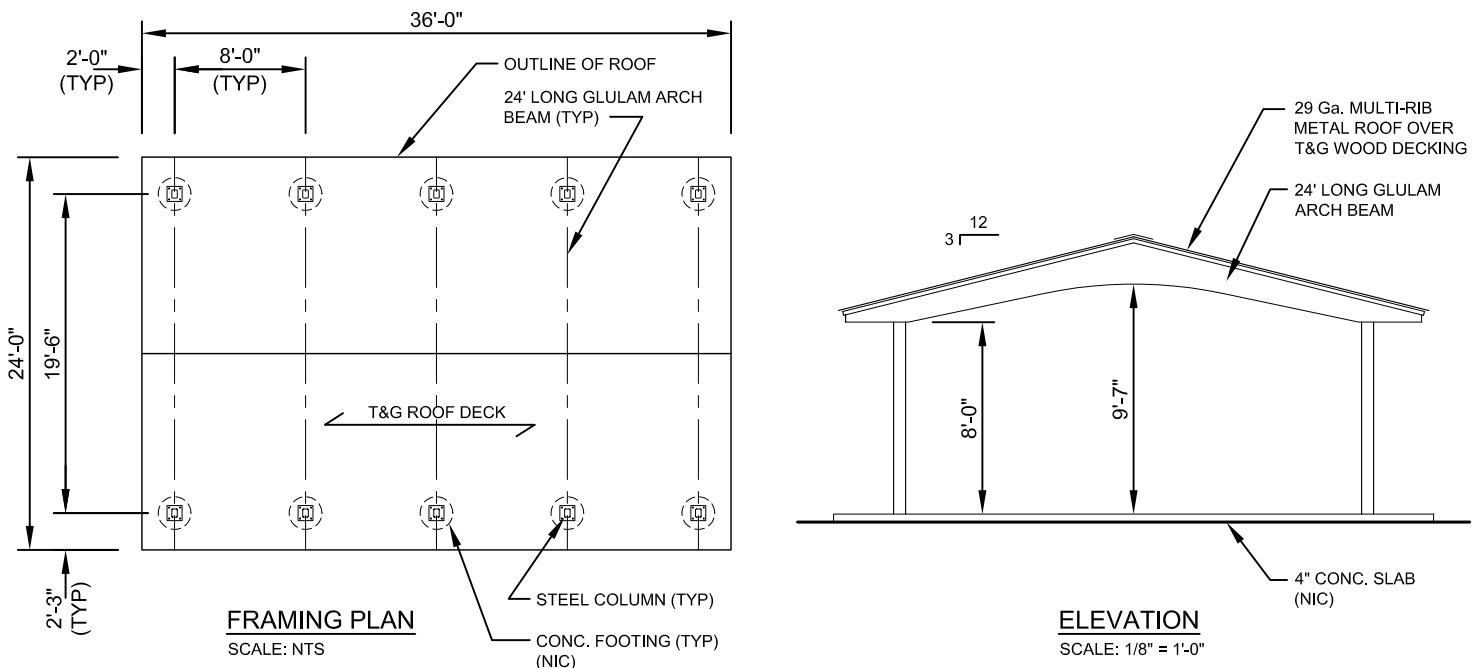

11800 East 9 Mile Road
Warren, MI 48089
Office: (586) 759-5490
Fax: (586) 754-9130
Toll Free: (800) 657-6118
Email: info@coverworx.net
www.CoverWorx.net

Woodworx Glulam Arch Beam Shelter - 24' x 36'

Model: GAB-2436-WW

DESIGN SPECIFICATIONS