

Steelworx Pergola, 14' x 20'

Steel: All structural members are ASTM A-500 U.S. grade B steel. Welded connection plates shall be ASTM A-36 hot rolled steel. Standard column dimensions shall be 5" x 5" x 1/8" tubular steel welded to 5/8" base plate with anchor bolts. Main support headers are 3" x 8" x 1/8" and rafters are 2" x 6" x 1/8". All steel connections to be bolted or screwed in place on-site.

Frame Finish: All steel framework will receive a corrosion protective TGIC Polyester powder coat, electro-statically applied and cured at 400°F. A large selection of standard colors are available. Hot-dipped galvanizing is also available upon request.

Hardware: All structural hardware provided and to be A-325 or B7 as required.

Shop Drawing: The fabricator shall furnish a complete set of installation drawings.

Not Included: Concrete or masonry work of any kind, decorative covers, unloading of product and installation.

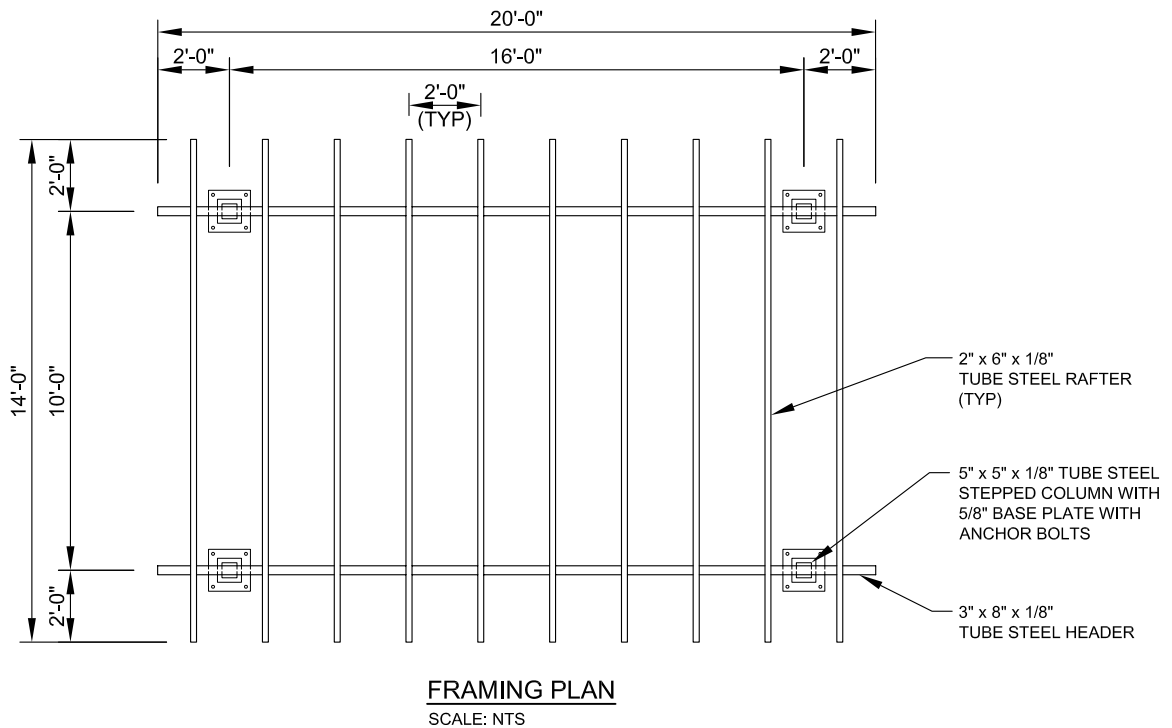
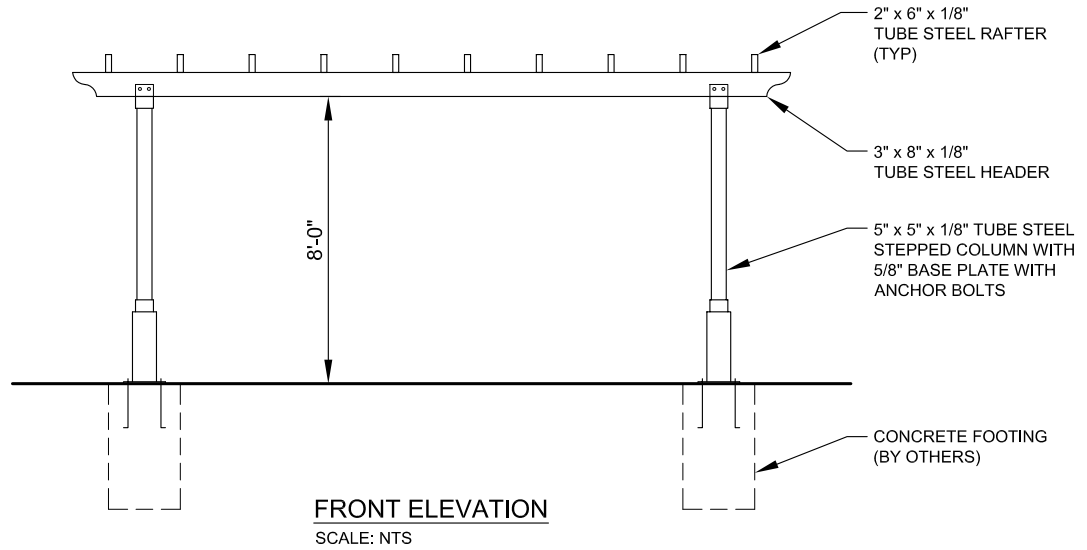

11800 East 9 Mile Road
Warren, MI 48089
Office: (586) 486-1088
Fax: (586) 754-9130
Toll Free: (800) 657-6118
Email: info@coverworx.net
www.CoverWorx.net

Steelworx Pergola - 14' x 20'

Model: PG-1420-SW

DESIGN SPECIFICATIONS