

Model: Woodworx Gable Shelter, 30' x 18'

Manufacturing Mission: To provide all prefabricated components and installation instructions for a 30' wide by 18' long (measured from eave to eave) free standing bolt together, tubular steel and wood constructed shelter kit.

Design Criteria: Structure is typically designed for a 25 lb live load and a 90 mph wind load capacity, but can be designed based on specific site requirements upon request.

Wood Framing: Standard columns shall be 6" x 6" (nom.) Southern Yellow Pine, pressure-treated #1 SPIB Grade, embedded into concrete footings. Also available with tube steel columns with surface mount base plates. Rafter beams shall be 5" x 12" (nom.) pre-cut glue-laminated wood. Glue-laminated wood shall be AITC Architectural grade Southern Yellow Pine with one coat of factory-applied clear penetrating sealer on exposed faces. Sizes are preliminary and may change upon final engineering based on actual site conditions and load requirements (site specific engineering shall be an additional cost).

Fascia: 2" x 6" (nom.) Southern Yellow Pine, pressure-treated #1 SPIB Grade.

Steel Connection Plates: Steel plates used for main framing connections shall be provided and shall be of ASTM A-36 hot rolled steel. All welding performed to latest AWS standards by ASTM Certified welders.

Steel Finish: All steel frame members and plates will receive a corrosion protective TGIC Polyester powder coat, electro-statically applied and cured at 400°F. A large selection of standard colors are available.

Roof Deck: 2" x 6" (nom.) #1 Grade, end matched, single tongue and groove with V-joint bottom face, Southern Yellow Pine.

Roofing: 29 Ga. pre-cut steel panels with Kynar 500 finish in a variety of colors with white underside. Standard roof slope is a 4/12 pitch with a eave height of 11'-0". Also available with 6/12 or 8/12 pitch roof. Attached to wood decking with exposed fasteners painted to match roof color. Includes matching 24 Ga. trim.

Foundation: All columns need to be anchored to concrete footings (footing design provided separately). Standard columns are surface mounted with anchor bolts at or below finish slab elevation. Columns can also be embedded directly into the footing for an extra cost.

Hardware: All structural hardware and roofing fasteners shall be provided.

Warranty: 5 years against manufacturer defects.

Not Included: Concrete work of any kind, unloading of product and installation.

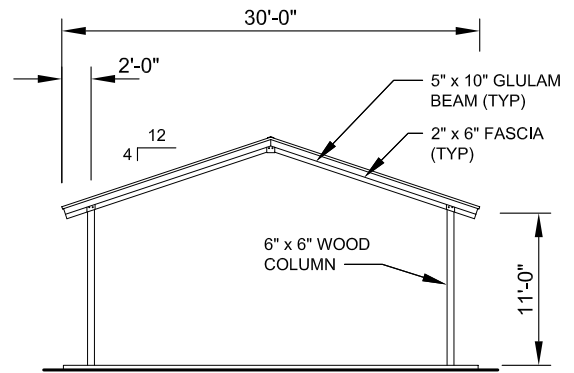

FRONT ELEVATION
SCALE: NTS

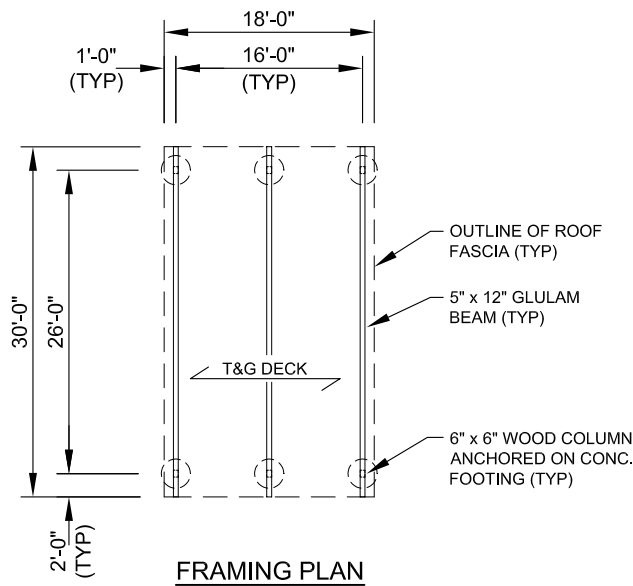

FRAMING PLAN
SCALE: NTS

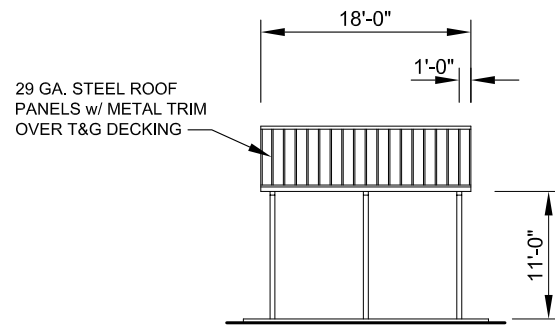

SIDE ELEVATION
SCALE: NTS



11800 East 9 Mile Road
Warren, MI 48089
Office: (586) 486-1088
Fax: (586) 754-9130
Toll Free: (800) 657-6118
Email: info@coverworx.net
www.CoverWorx.net

Woodworx Gable Shelter - 30' x 18'

Model: GA-3018-WW

DESIGN SPECIFICATIONS